

SoundEffects™

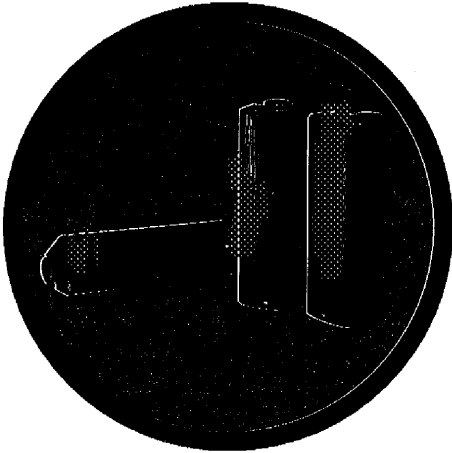

movies20 simple set-up guide

thank you for choosing JBL. For over 50 years, JBL has been involved in every aspect of musical and film recording and reproduction, from live performances to monitoring the recordings you play in your home, car, or office.

We're confident that the **JBL system** you have chosen will provide every note of enjoyment that you expected – and that when you think about purchasing additional audio equipment for your home, car, or office, you will once again choose JBL.

Please take a moment to complete the enclosed profile card. It enables us to keep you posted on our latest advancements, and helps us to better understand our customers and build products that meet your needs and expectations.

JBL Consumer Products

included

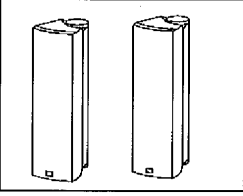

Two surround speakers.

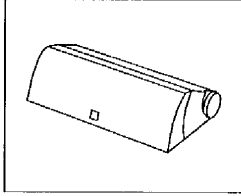

One sat20 center speaker.

features

- 2-way speakers with 3/4" titanium composite dome high-frequency drivers.
- Adjustable, removable wall-mounting brackets (included for all speakers).
- Video-shielded center speaker.
- Recessed wire channels on center and surrounds.
- Diffraction-limiting foam satellite baffles.

one. Speaker Placement

Center

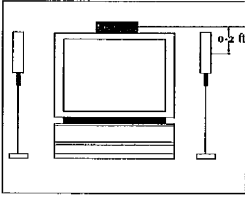

Surrounds

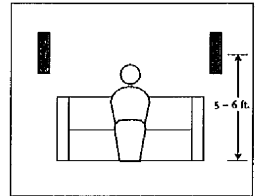
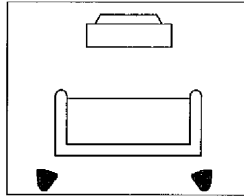

Mounting Options

Center

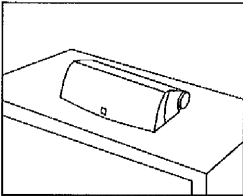

On TV.

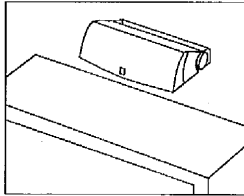

Wall-mounted. Brackets and hardware included.

Surrounds

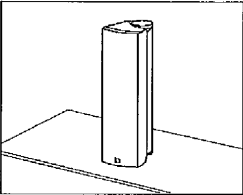

On shelves.

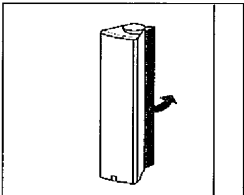

Wall-mounted. Brackets and hardware included.

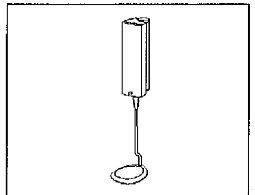

On optional stands.
Part No. FS10/20.
FS10/20WHT(white).

two. Speaker Connections

Connection Tips

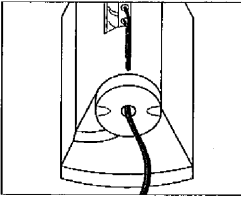

Thread speaker wire through the hole in the bottom of the speaker, then feed it through the recessed wire channel.

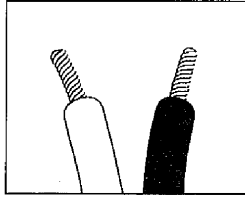

Separate and strip the ends of the speaker wire as shown. Speakers and electronics terminals have corresponding (+) and (-) terminals. It is important to connect both speakers

identically: (+) on the speaker to (+) on the amplifier and (-) on the speaker to (-) on the amplifier. Wiring "out of phase" results in thin sound, weak bass and a poor stereo image.

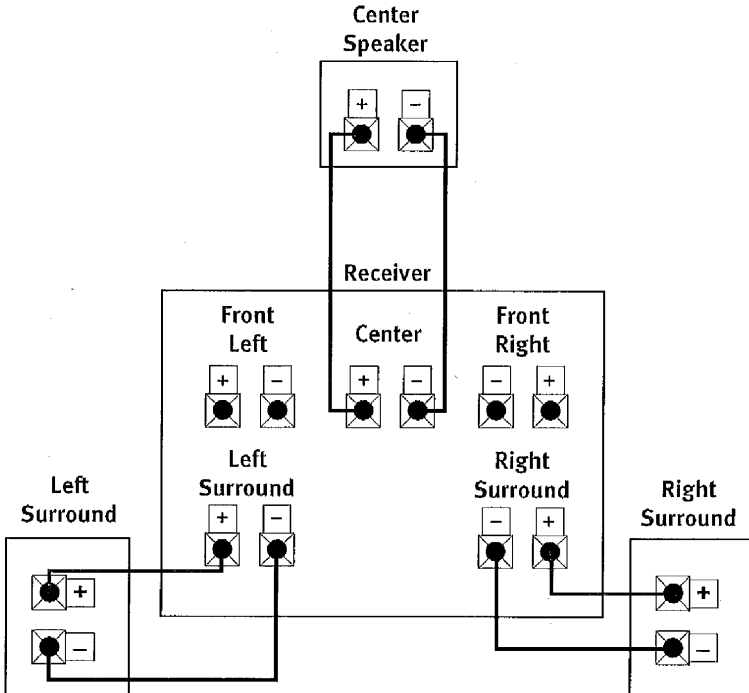

Troubleshooting

If there is no sound from the surround speakers, check the following:

- Check all wires and connections between receiver/amplifier and speakers. Make sure all wires are connected. Make sure none of the speaker wires are frayed, cut, or punctured.
- Review proper operation of your receiver/amplifier and its surround sound features.
- Make sure the movie or TV show, you are watching is recorded in Dolby® surround. If it is not, check to see if your receiver/amplifier has other surround modes you may use.

If there is no sound from the center speaker, check the following:

- Make sure that your receiver's Center Channel Mode is in the "normal" or "wide" position. If it is in the "phantom" position, the center speaker will not play.
- Check all connections between processor/amplifier and the center speaker.

If the system plays at low volumes but shuts off as volume is increased, check the following:

- Check all wires and connections between receiver/amplifier and speakers. Make sure all wires are connected. Make sure none of the speaker wires are frayed, cut, or punctured.
- If more than one pair of main speakers is being used, check the minimum impedance requirements of your receiver/amplifier.

Specifications

movies20 System

Frequency Response
120Hz – 20kHz (±3dB)

Center & Surround

Recommended Power
10 – 120 watts

Frequency Response
120Hz – 20kHz (±3dB)

Impedance
8 ohms nominal

Sensitivity
90dB @ 1 watt/1 meter

Crossover Frequency
3.5kHz (midrange to tweeter)

Tweeter
One 3/4" titanium composite dome, video-shielded

Midrange
Two 3-1/2" neodymium drivers, video-shielded

Dimensions (HxWxD)
14 x 4-3/8 x 6 inches

356 x 111 x 152mm

Weight
3.5 lbs/1.6 kg

Refinements may occasionally be made to existing products without notice, but will always meet or exceed original specifications unless otherwise stated.



JBL Consumer Products
80 Crossways Park West, Woodbury, NY 11797
8500 Balboa Boulevard, Northridge, CA 91329
1-800-336-4JBL (4525) (USA only)

© 1996 JBL, Incorporated. JBL is a registered trademark and SoundEffects is a trademark of JBL, Incorporated. Dolby Pro Logic is a registered trademark of Dolby Laboratories Licensing Corporation.
Printed in USA 7/96  Part No. MOVIES200M

 A Hamam International Company

Declaration of Conformity



We, JBL Europe A/S
Kongevejen 104B
DK-2460 Birkeroed
DENMARK

declare in own responsibility, that the loudspeakers
described in this owner's manual are in compliance with
technical standards:
EN 50 081-1:1992
EN 50 082-1:3.1995

Steen Michaelson
JBL Europe A/S
Birkeroed, DENMARK, 7196